



Enclosure Install Guide

www.rachio.com/support



Before you begin...

Before starting installation of this fixture or removal of a previous fixture, disconnect the power by turning off the circuit breaker or by removing the fuse at the fuse box.

CONSULT A QUALIFIED ELECTRICIAN IF YOU HAVE ANY ELECTRICAL QUESTIONS.

Do not use the white controller cover when using a Rachio outdoor enclosure.

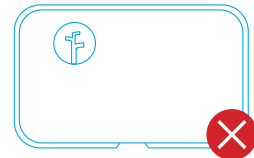
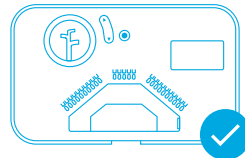

Need help?

We have a team of experts ready to help. If you run into any problems, please contact Rachio customer support.

1 (844) 4-RACHIO

Complete support documentation, videos and more are available on our support site.

www.rachio.com/support

What's in the box?

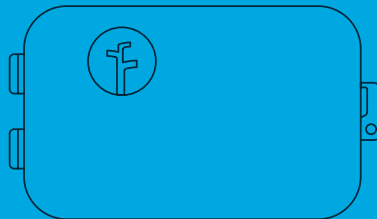

outdoor enclosure



bolts



washers

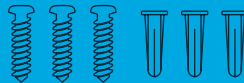

**drywall screws
and anchors**

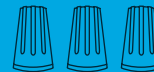

connector caps

What you'll need...



drill and drill bit



hammer
(for drywall installs)



phillips screwdriver



wire strippers



pliers

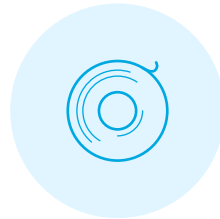

electrical tape

Easy Install

6 Quick Steps

1 Download

✓ Download the Rachio app at www.rachio.com/download.



✓ Create a Rachio user account to set up and manage your controller. You'll need to create a username and password to connect your controller.

2 Connect

- ✓ Connect your controller to Wi-Fi using your smartphone and the app at the location where you will install the controller. Connecting to Wi-Fi before installation ensures the signal is strong enough before disconnecting any wires.
- ✓ The Rachio app will guide you through connecting your controller to Wi-Fi.

3 Remove



Test your sprinkler system.

Check your sprinkler system by turning on each zone with your old controller. Find and repair any issues with your sprinkler system prior to installing your controller.



Snap a few pictures.

Open the old controller. Use your phone to take a few photos of the wiring inside the old controller from different angles. This will come in handy when it's time to wire your Rachio controller.



Disconnect power to controller.

Before removing your old controller, disconnect the power by turning off the circuit breaker or by removing the fuse at the fuse box.

3 Remove (continued)



CONSULT A QUALIFIED ELECTRICIAN IF YOU HAVE ANY ELECTRICAL QUESTIONS.



Remove your old controller.

Disconnect the wires from your old controller, then remove it from the wall. You're ready to mount the Rachio enclosure.

4 Mount



Measure and prepare.

Using a pencil or pen, position the enclosure against the wall and mark the mounting screw locations you intend to use. Remember to account for existing conduit (if present), as the Rachio enclosure might need to be mounted off center from the old controller.

Exact measurements are on the following pages.

4 Mount (continued)

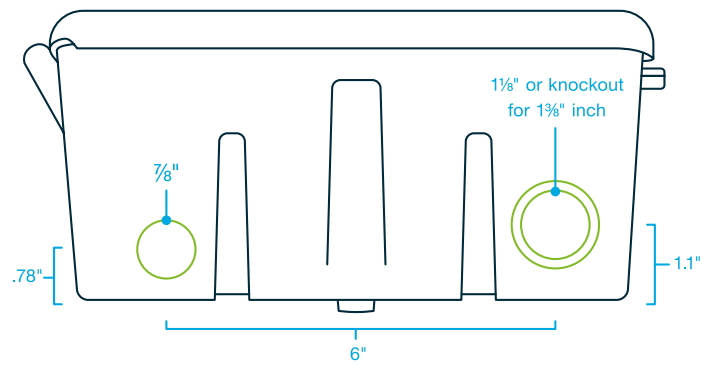

Bottom of Enclosure

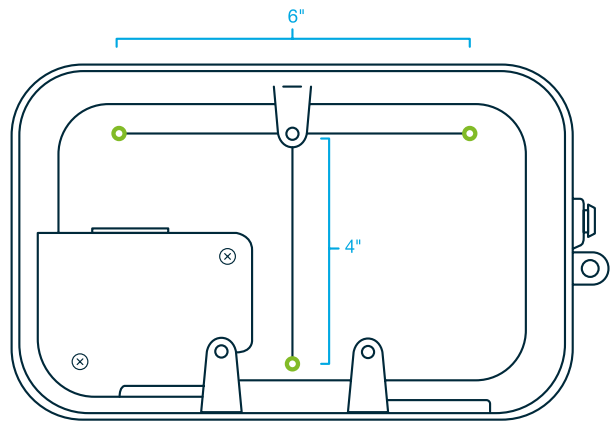

Interior of Enclosure

4 Mount (continued)



Drill pilot holes.

Drill pilot holes at the marked locations.

Note: The pilot holes should be approximately the same size as your anchor. Hammer the anchor in the pilot hole until the lip on the end is flush with the wall.



Mount the enclosure.

Attach the Rachio enclosure to the wall.

5 Hardwire

The enclosure is designed with an internal outlet to use the power adapter included with the Rachio controller. Rachio recommends hardwiring the enclosure.

DO NOT DIRECTLY HARDWIRE YOUR RACHIO CONTROLLER. ONLY HARDWIRE USING THE ENCLOSURE.

For detailed instructions visit www.rachio.com/enclosure.



Open the Hardwiring Bay to access the enclosure outlet wiring.



Insert power wires through the bottom left hole of the enclosure.

5 Hardwire (continued)

- ✓ Connect the wires as follows: white (neutral) to white, black or red (hot) to black, and green (ground) wire to the bare copper wire from the junction box. Twist the wire from the supply side and the Rachio enclosure together in a clockwise direction using a connector cap. Wrap all wire connections with electrical tape for a secure connection. Repeat for all wires.
- ✓ Insert all wires into the hardwiring bay and close the lid of the Hardwiring Bay.
- ✓ Reconnect the power by turning on the circuit breaker or by replacing the fuse at the fuse box.

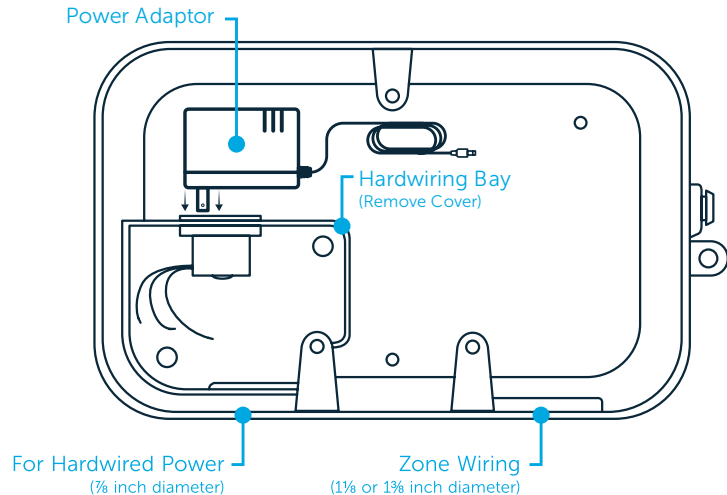

6

Mount Controller

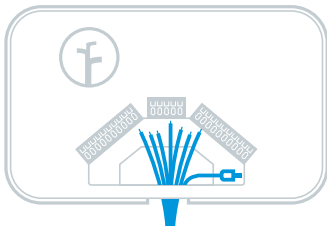

Push wiring into wiring bay.

Plug the power adaptor into the internal outlet of the enclosure. Feed the sprinkler wires through the bottom right hole of the enclosure, and pull through the center opening on the controller's base.

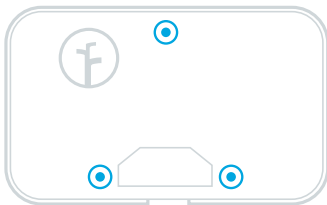

Mount to enclosure.

Attach the controller to the enclosure using the included bolts using the top center and two bottom (do not use the center middle)

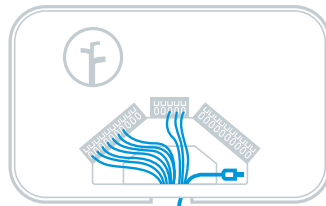

Wire it up.

Connect the zone wires to the corresponding terminal locations. Reference photos of your previous wiring. Finally, plug the power adaptor into your controller.

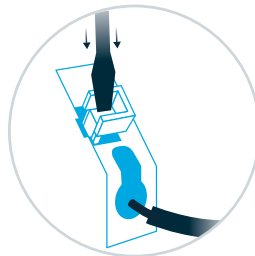

Note: To insert or remove a wire, press down on each terminal tab with a screwdriver.

DO NOT ATTACH THE WHITE CONTROLLER COVER WHEN USING AN OUTDOOR ENCLOSURE.

©2017 Rachio, Inc.